

# CAMP ZINCS

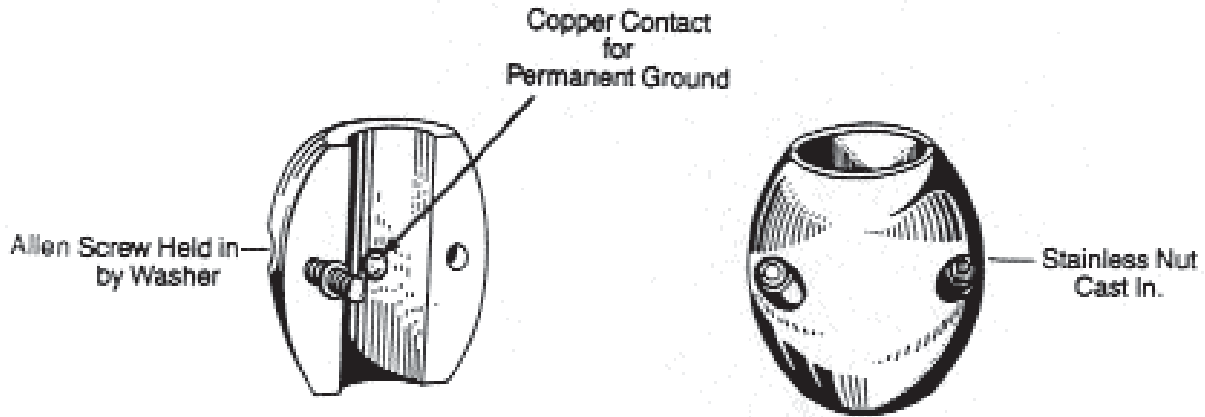

## Metric Size Collars For Shaft

Part No.	Shaft Size		Outer Diameter		Length		List Price
	MM	Thousands of an inch	MM	Fractions	MM	Fractions	
D 25	25MM	.984	54MM	2-1/8"	61MM	2-3/8"	\$11.20
D 30	30 MM	1.181	59MM	2-5/16"	64MM	2-1/2"	14.15
D 35	35MM	1.378	67MM	2-5/8"	70MM	2-3/4"	16.95
D 40	40MM	1.575	84MM	3-5/16"	77MM	3-1/32"	36.55
D 45	45MM	1.772	84MM	3-5/16"	77MM	3-1/32"	32.85

U.S. Mil-A-18001 Specification

## Barrel Collars for Shaft

Part No.	Shaft Size	Std. Box	List Price
x-0	1/2"	----	\$12.51
x-1	3/4"	24	8.88
x-1A (Ex. Hvy.)	3/4"	24	12.99
x-2	7/8"	24	8.65
x-2A (Ex. Hvy.)	7/8"	24	12.41
x-3	1"	24	9.77
x-3A (Ex. Hvy.)	1"	24	11.85
x-4	1-1/8"	24	11.20
x-5	1-1/4"	24	11.52
x-5A (Ex. Hvy.)	1-1/4"	12	18.75
x-6	1-3/8"	12	14.86
x-7	1-1/2"	12	14.86
x-8	1-3/4"	8	23.56
x-9	2"	8	24.48
x-10	2-1/4"	4	51.93
x-11	2-1/2"	4	50.38
x-12	2-3/4"	4	70.49
x-13	3"	4	60.40
x-14	3-1/4"	2	99.57
x-15	3-1/2"	2	78.78
x-17	4"	2	90.82
x-18	4-1/2"	2	104.86

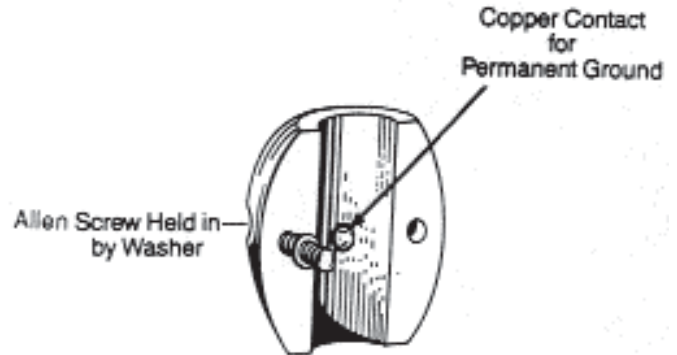

## Donut Collars for Shaft

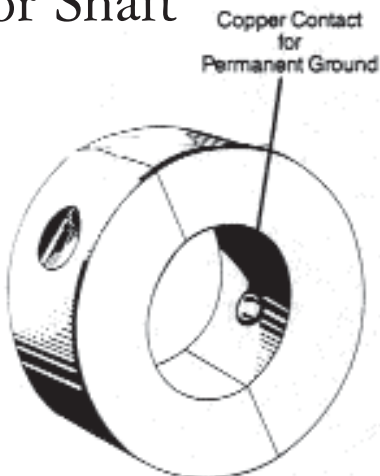

Part No.	Shaft Size	O.D. Dia	Width	Std. Box	List Price
C-1	3/4"	2-1/8"	1"	5	\$10.28
C-2	7/8"	2-1/8"	1"	5	10.28
C-3	1"	2-1/2"	1-1/4"	10	14.05
C-4	1-1/8"	2-1/2"	1-1/4"	5	14.05
C-5	1-1/4"	2-1/2"	1-1/4"	10	14.05
C-6	1-3/8"	3"	1-1/4"	6	16.92
C-7	1-1/2"	3"	1-1/4"	6	16.92
C-8	1-3/4"	3-1/2"	1-3/8"	5	23.37
C-9	2"	3-1/2"	1-3/8"	5	23.37
C-10	2"	4"	1-1/2"	8	29.77
C-11	2-1/4"	4"	1-1/2"	8	29.77
C-12	2-1/2"	5"	1-1/2"	5	40.76
C-12A	2-3/4"	5"	1-1/2"	5	40.76
C-13	3"	5"	1-1/2"	5	40.76
C-14	3-1/2"	6-1/2"	1-1/2"	4	50.20
C-15	4"	6-1/2"	1-1/2"	4	50.20

## For Rudders

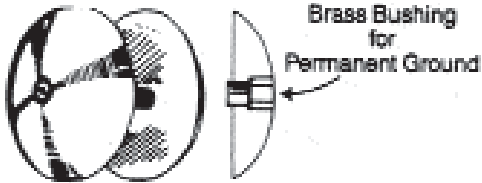

Part No.	Diameter	Std. Box	List Price
R-1	1-7/8"	----	\$3.54
R-2	2-13/16"	25	10.28
R-3	3-3/4"	20	14.67
R-4	5"	8	26.67
R-5	5-1/8"	6	39.23
R-7	6-1/2"	2	59.73

## Tear Drop -- For Hull



Part No.	Length	Std. Box	List Price
T-20	3-1/2"	50	\$ 5.30
T-21	5-1/4"	25	\$ 12.35

## Hull Plate With Bonding Wire\*

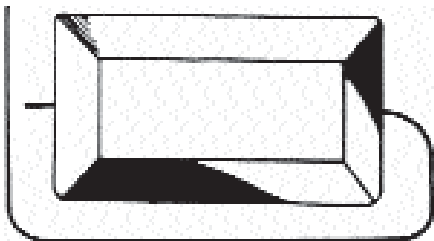

Part No.	Length	Width	Thickness	List Price
CZP-1	4-1/2"	2-1/2"	11/16"	\$ 17.05
CZP-2	6"	3"	3/4"	25.08
CZP-3	6"	4"	3/4"	30.70
CZP-4	9"	5"	13/16"	49.68

\* No. 12 Copper - 14" Long

## Plate For Hull



A-24



A-25

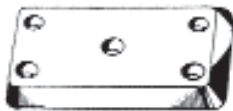

A-30



A-40

Top View

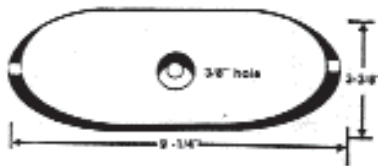

A 90  
(Pacemaker Style)



Side View

Part No.	Length	Width	Thickness	Weight	Std. Box	List Price
A-24	4-3/4"	2"	3/4"	12 oz.	25	\$ 7.57
A-25	9-1/4"	3-3/8"	3/4"	3-1/4 lb.	10	37.22
A-30	6-1/4"	2-3/4"	5/8"	2 lb.	25	15.41
A-40	7-1/4"	2-3/4"	1/2"	2-1/2 lb.	10	15.56
A-90	9-1/4"	3-3/8"	53/64"	2-1/2 lb.	5	37.22
ZHC-3	6-1/4"	2-3/4"	3/4"	2 lb.	5	31.48
ZHC-5	8"	4"	3/4"	5lb.	4	51.42
DP-1	11-1/2"	5-1/4"	5/8"		4	116.36

Top View



ZHC-3

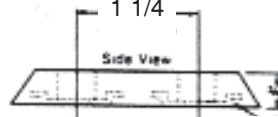

Aluminum Plate tab cast in



DP-1  
Divers Plate

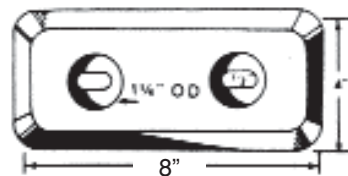

ZHC-5

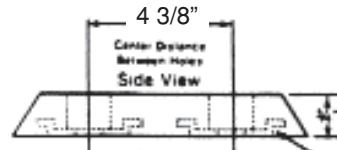

Aluminum Plate tab cast in

## Zinc Grouper

Zinc Grouper comes with 20 ft. galvanized wire rope and an electrical contractor with instruction sheet enclosed.

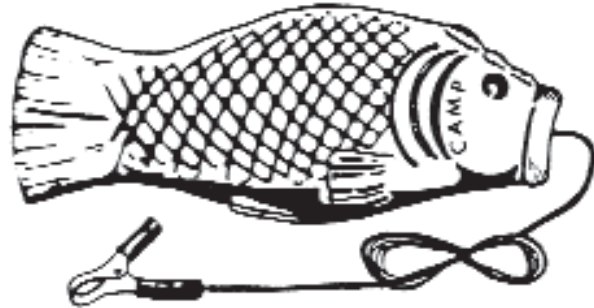

Nominal weight 6 lbs.                      \$116.36

## Keel Cooler Anodes

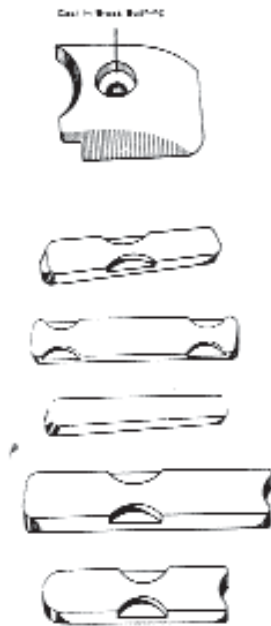

Part No.	Description	List Price
Z-1	For sizes 1/2", 3/4", 1" Single Stem & 1-1/4" & 1-1/2" Double Stem 4 tube 1 -- 1-1/8" fluted.	\$ 10.52
Z-2	For sizes 1-1/4" & 1-1/2", 1" Single Stem & 2" & 2-1/2" Double Stem 4 tube 1-1/2" turbo tube.	12.51
Z-3	For sizes 2", 2-1/2", 3" & 4" Single Stem & 3" & 4" Double Stem	25.95
X-45-3	For 2 tube 1-1/8" ends	3.45
X-47-3	For 4 tube 1-1/8" ends	8.62
X-58	May be cut to fit	6.24
X60-3	For 8 tubes 1-1/8" ends	11.81
X61-3N	For 6 tubes 1-1/8" ends	9.84

## Crab Trap Zinc

Part No.



Crab Trap Zinc with cast-in galvanized wire for grounding.

Nominal weight 6 lbs.                      \$12.31

## For Mercury Outdrives & Outboards

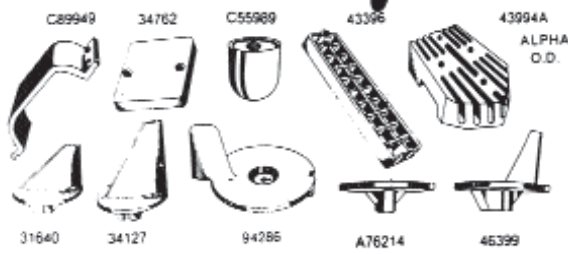

Part No.	H.P.	Std. Box	List Price
34127		25	\$11.89
31640		40	10.14
46399		10	10.54
A72614		5	8.69
34762		10	4.79
C55989		---	2.91
C89949		5	34.15
43396	75-115	5	16.96
94286	25	6	7.21
43994A		5	22.99

## For OMC Outdrive

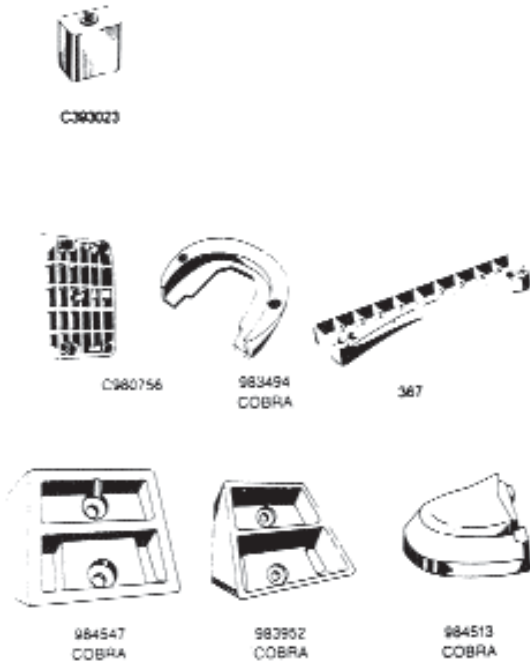

Part No.	Length	Distance between hole centers	Std. Box	List Price
367	7-5/8"	6-15/16"	20	11.56
393023	-----	-----	10	13.32
397768	-----	-----	-----	12.19
C980756	-----	-----	20	20.60
983494	-----	-----	10	32.27
983952	-----	-----	5	43.64
984513	-----	-----	5	26.78
984547	-----	-----	2	33.76
986158	-----	-----	-----	13.51
987067	-----	-----	-----	12.51

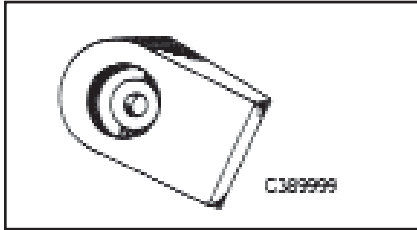

## For OMC Sail Drive

Part No. C389999      \$13.91

## For OMC Sea Drive

Part No. C983191      \$30.96

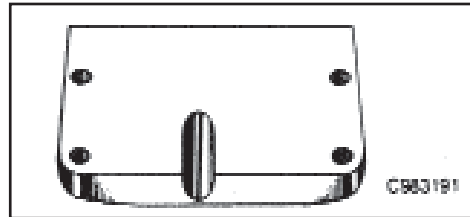

## For Johnson & Evinrude Outboards

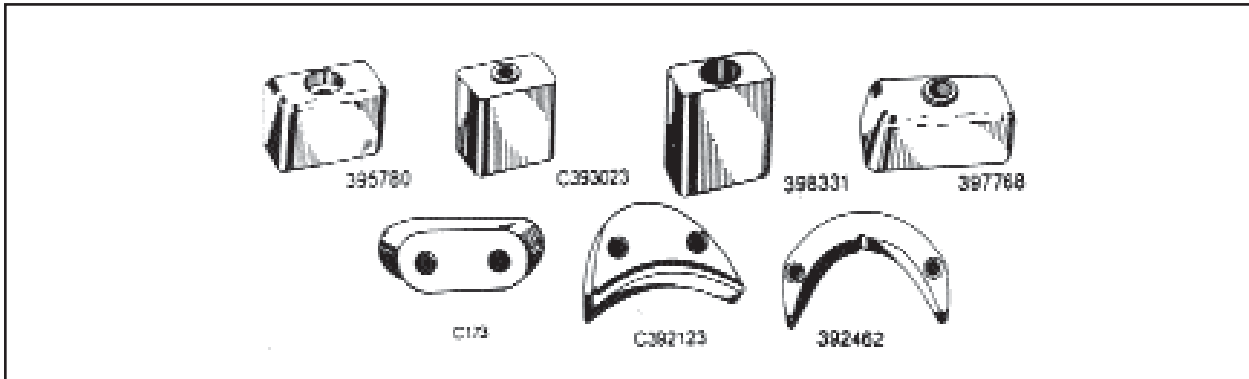

Part No.	H.P.	Model Year	Std. Box	List Price
C392123			10	\$26.40
C393023			10	12.45
392462	50-75	1982 to Present	10	28.59
395780		1984 to Present	---	11.11
398331	275		---	13.04
397768	8 Cylinder Outboards	1985 to Present	---	12.20
C173	For All Outboards			7.76

All Rights Reserved Jan. 1991

## For Marine Engines Zinc Pencils With Bronze Plug\*



\* Above available in complete units or zinc only.

Part No.	Plug I.P.S.	Zinc Dimensions	List Price Zinc Only	List Price Complete
E-00	1/8"	1/4" x 2"	\$ .82	\$ 2.83
E-00A	1/8"	1/4" x 1/2"	.55	2.48
E-0	1/4"	3/8" x 1-3/4"	1.22	3.16
E-0A	1/4"	3/8" x 2-1/2"	1.56	3.53
E-0B	1/4"	3/8" x 3/4"	1.22	3.16
E-1	3/8"	1/2" x 2"	1.77	5.28
E-1D	3/8"	1/2" x 1-3/4"	1.77	5.28
E-1E	3/8"	1/2" x 1-1/2"	1.77	5.28
E-1F	3/8"	1/2" x 1-1/4"	1.77	5.28
E-1G	3/8"	1/2" x 1"	1.77	5.28
E-1H	3/8"	1/2" x 1-5/8"	1.77	5.28
E-1J	3/8"	1/2" x 5/8"	1.77	5.28
E-2	1/2"	5/8" x 2"	2.09	6.64
E-2B	1/2"	5/8" x 3"	2.47	6.23
E-3	3/4"	3/4" x 2"	2.74	9.18
E-3A	3/4"	3/4" x 3/4"	2.07	8.16
E-4	3/4"	3/4" x 3-3/8"	3.23	9.76
E-5	3/4"	3/4" x 3-5/8"	3.48	10.20
E-6	3/4"	3/4" x 4-3/4"	5.61	14.44
E-7	1"	1-1/16" x 5"	9.63	28.73
E-7A	1"	1-1/16" x 10"	18.76	38.24
E-8	1-1/4"	1-1/4" x 2-5/16"	8.00	29.48
E-8A	1-1/4"	1-1/16" x 6"	14.44	36.75
E-8B	1-1/4"	1-1/16" x 10"	13.23	39.04

## For Renault Marine Engines\*

Part No.	List Price Zinc Only	List Price Complete
C94619	\$4.74	\$15.28



\* Available in complete units or zinc only. C-94619

## For Yanmar Marine Engines

 <p style="font-size: small; text-align: center;">C272100-200300      C-300      C10421141-300</p>	<table border="1" style="width: 100%; border-collapse: collapse;"> <thead> <tr> <th style="text-align: left;">Part No.</th> <th style="text-align: left;">List Price</th> </tr> </thead> <tbody> <tr> <td>C272100-200300</td> <td>\$ 8.78</td> </tr> <tr> <td>C10421141-300</td> <td>10.65</td> </tr> <tr> <td>For 300 H.P. Engines: C-300</td> <td>14.36</td> </tr> </tbody> </table>	Part No.	List Price	C272100-200300	\$ 8.78	C10421141-300	10.65	For 300 H.P. Engines: C-300	14.36
Part No.	List Price								
C272100-200300	\$ 8.78								
C10421141-300	10.65								
For 300 H.P. Engines: C-300	14.36								

## For Caterpillar Marine Engines

Part No.	Plug I.P.S.	Zinc Dimensions	List Price Zinc Only	List Price Complete	
6L2016**	3/4"	3/4" x 3/4"		\$11.89	
6L2280*	3/8"	1/2" x 1-5/8"	\$ 1.95	6.15	
6L2283**	1/4"	3/8" x 2-1/2"		3.73	
6L2289*	1/2"	5/8" x 3"		7.58	
CL2285*	1" x 1/4"	1-1.4" x 2-5/16"	8.87	35.69	

\*\* Sold Complete Only

\* Above available in complete units or zinc only

## For GM Marine Engines\*

	<table border="1" style="width: 100%; border-collapse: collapse;"> <thead> <tr> <th style="width: 15%;">Part No.</th> <th style="width: 15%;">Plug I.P.S.</th> <th style="width: 20%;">List Price Zinc Only</th> <th style="width: 45%;">List Price Complete</th> </tr> </thead> <tbody> <tr> <td>8515850</td> <td>3/4"</td> <td>\$ 3.66</td> <td>\$19.33</td> </tr> <tr> <td>8517479</td> <td>1/2"</td> <td>2.20</td> <td>14.96</td> </tr> </tbody> </table>	Part No.	Plug I.P.S.	List Price Zinc Only	List Price Complete	8515850	3/4"	\$ 3.66	\$19.33	8517479	1/2"	2.20	14.96
Part No.	Plug I.P.S.	List Price Zinc Only	List Price Complete										
8515850	3/4"	\$ 3.66	\$19.33										
8517479	1/2"	2.20	14.96										

\* Above available in complete units or zinc only

## Collars for Volvo Outdrive

V-15, V-16, V-17	V-18			
852835	852898			
8758121	875812			
823661	838929			

Part No.	Model	Std. Box	List Price
V-15 (875810)	100	---	\$ 6.05
V-16 (875809)	200	---	7.21
V-17 (875805-4)	250-270	---	8.72
V-18 (875815-3)	270T-280	10	17.93
832598	250-270	20	17.37
852835	290B	10	37.62
875821	Duo Prop	5	21.29
875812	110 Sail Dr.	---	16.96
838929			3.91
823661	Diesel	---	5.14

## For Suzuki Outboards

Part No.	H.P.	Std. Box	List Price
55320-95310	55-140	---	\$ 6.76
55125-9630	20-30	---	13.23
55125-87DOO	150-200	5	9.15
55125-94502	115-140	---	7.85
55125-94400			7.49

## For Yamaha Outboards

6E5-45251	688-45251	6H1-45251	6G5-45251	
664-45371	688-45371	6J9-45371	688-45371-02	

Part No.	H.P.	Std. Box	List Price
6E5-45251	115-200	---	\$ 3.64
688-45251	40-90	---	1.37
688-45371		5	33.20
664-45371		5	14.46
688-45371-02		5	19.32
6G5-45251	115-200	5	15.89
6J9-45371		5	12.92
6H1-45251	40-90	5	11.95







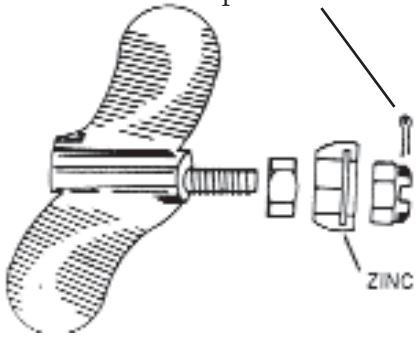





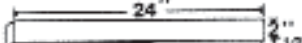

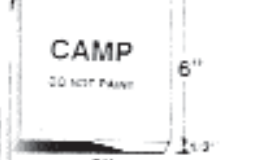
## Nissan & Toshiba Outboards

	Part No.	H.P.	Std. Box	List Price
	34860-2170M	40-70	5	\$ 7.73

## Zinc Propeller Nuts -- Patent #259811

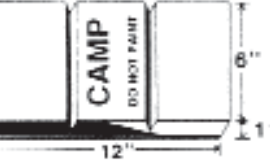
Zinc Only Part#	Brass Nut Kit Only Part #	Shaft Size	List Price Zinc Only	List Price Brass Nut	Cross-section View Cast in Bronze Spacer 
P-1	PN-1	3/4"	\$12.22	\$22.71	
P-2	PN-2	7/8"	13.69	23.02	
P-3&4	PN-3&4	1"	15.28	31.10	
P-5	PN-5	1-1/4"	15.28	34.24	
P-6	PN-6	1-3/8"	18.47	45.39	
P-7	PN-7	1-1/2"	20.99	69.59	
P-8	PN-8	1-3/4"	25.21	81.60	
P-9	PN-9	2"	28.97	129.68	

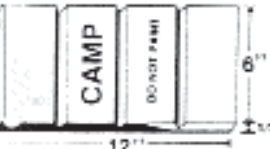
# ALL ANODES LISTED ARE OF MIL-SPEC

	<p>ZP-1 \$120.47 Zinc Plate 6" x 12" x 1/2" Smooth Finish, Similar to Roll Zinc. Nominal Weight - 9 lbs.</p>		<p>ZP-9 \$231.25 Zinc Plate 6" x 12" x 1/2" -- 3 Score. This can be broken into 4 Sections Nominal Weight - 17 lbs.</p>
	<p>ZP-2 \$100.70 Zinc Plate 6" x 12" x 1/2" Nominal Weight - 9 lbs. CAST ZINC CANNOT BE BENT</p>		<p>ZP-10 \$100.70 2" x 24" x 1/2" Nominal Wt. - 7 lbs.</p>
	<p>ZP-3 \$44.76 Zinc Plate 4" x 6" x 1/2" Nominal Weight - 9 lbs.</p>		<p>W-6 \$79.44 Tear Drop Anode has cast-in galvanized steel strap with two 3/8" holes. Nominal Weight - 5 lbs.</p>
	<p>ZP-4 \$67.13 Zinc Plate 6" x 6" x 1/2" Nominal Weight - 4-1/2 lbs.</p>		<p>W-12 \$137.25 Anode has cast-in galvanized steel strap. Nominal Weight - 12 lbs.</p>
	<p>ZP-5 \$100.70 Zinc Plate 6" x 6" x 1/2" Nominal Weight - 9 lbs.</p>		<p>W-24 \$261.82 Tapered Zinc Anode with two cast-in galvanized steel straps. Nominal Weight - 23 lbs.</p>
	<p>ZP-6 \$100.70 Zinc Plate 6" x 12" x 1/2"--2 Score. This can be broken into 3 Sections. Nominal Weight - 9 lbs.</p>		<p>W-24-SQ. \$261.82 Rectangular Zinc Anode with two cast-in galvanized steel straps. Nominal Weight - 23 lbs.</p>
	<p>ZP-7 \$231.25 Zinc Plate 6" x 12" x 1/2"--2 Score. This can be broken into 3 Sections. Nominal Weight - 17 lbs.</p>		<p>B-6 \$78.84 Rectangular Zinc Anode with two cast in 7/16" I.D. Bronze Bushings. Nominal Weight - 17 lbs.</p>
	<p>ZP-8 \$111.88 Zinc Plate 6" x 12" x 1/2"--3 Score. This can be broken into 4 Sections. Nominal Weight - 9 lbs.</p>		<p>B-12 \$113.41 Tapered Zinc Anode with two cast in 7/16" I.D. Bronze Bushings. Nominal Weight - 9 lbs.</p>
			<p>B--24 \$241.65 Tapered Zinc Anode with two cast in 7/16" I.D. Bronze Bushings. Nominal Weight - 23 lbs.</p>